

# Ultracell®

'Quality in Every Language'

UCG275-12

12V 275Ah

Solar Series

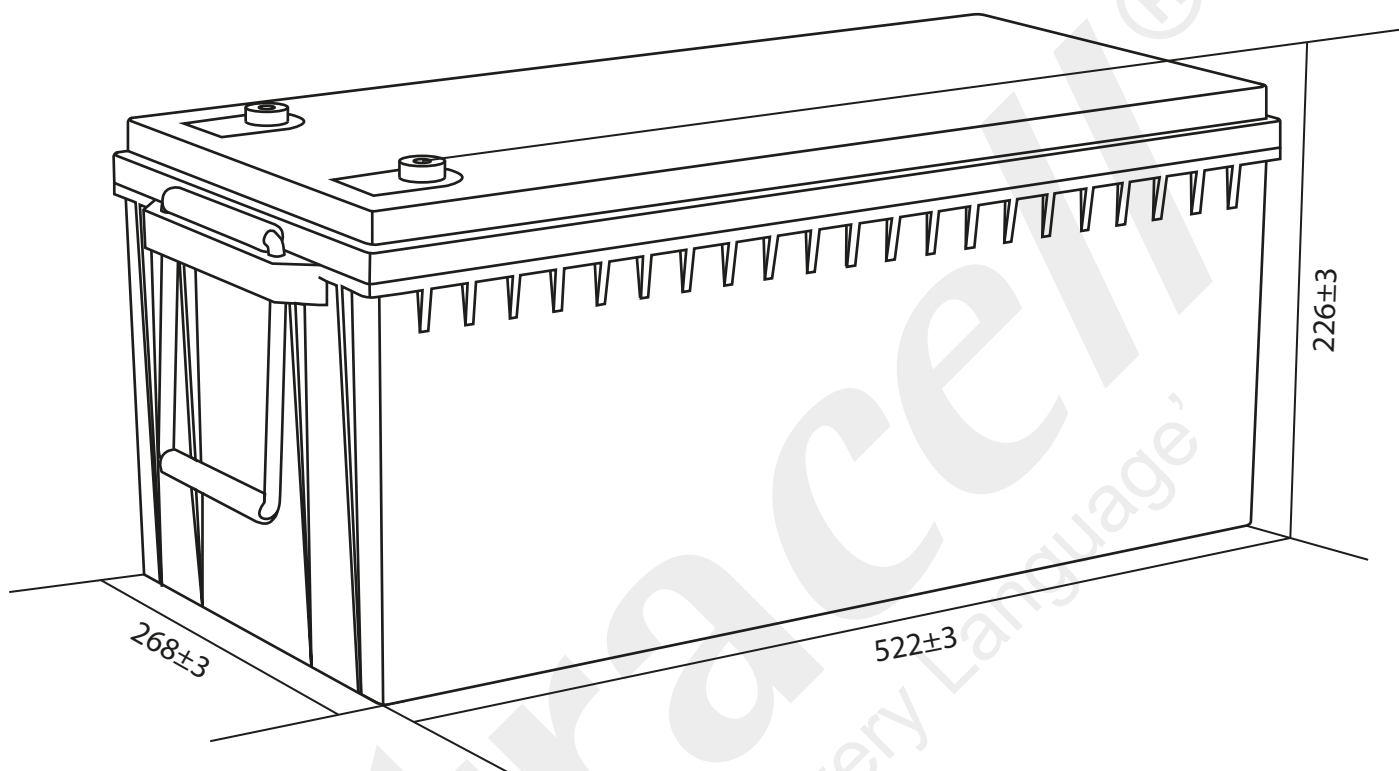

## Technical Dimensions (mm)

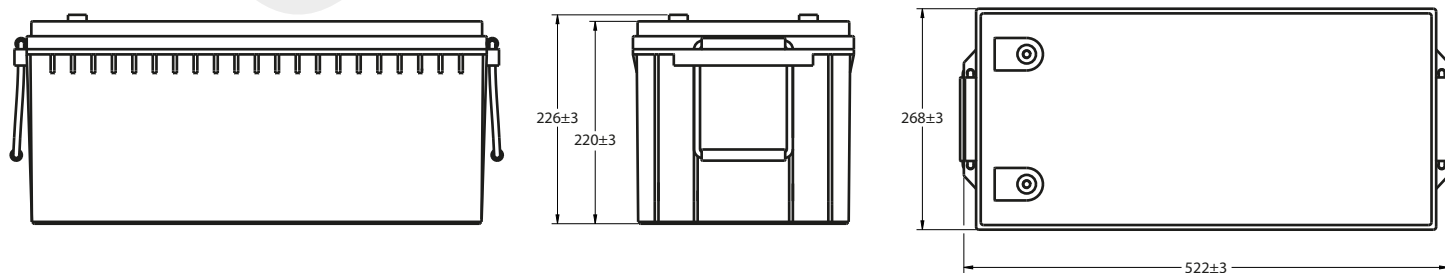



Image



Terminal Dimensions (mm)

Standard Terminal: F11

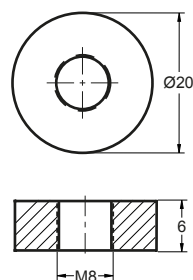

Technical Specification

<b>Output</b>	Nominal Voltage	12V
	Nominal Capacity (10HR)	275Ah
<b>Terminal Type</b>	Standard Terminal	F11
<b>Container Material</b>	Standard Option	ABS
	Flame Retardant Option (FR)	ABS (UL94:VO)
<b>Rated Capacity</b>	(20HR 1.80V/cell, 25°C)	281.0 Ah/12.9A
	(10HR 1.80V/cell, 25°C)	275.0 Ah/27.5A
	(5HR 1.75V/cell, 25°C)	240.0 Ah/48.1A
	(1HR 1.60V/cell, 25°C)	171.0 Ah/171.0A
<b>Max Discharge Current</b>	2500A (5s)	
<b>Internal Resistance</b>	Approx 2.5mΩ	
<b>Discharge Characteristics</b>	Operating Temp Range	Discharge: -15 ~ 50°C Charge: 0 ~ 40°C Storage: -15 ~ 40°C
	Nominal Operating Temp Range	25 ± 3°C
	Cycle Use	Initial Charging Current less than 82.5A. Voltage 14.4V ~ 15.0V @ 25°C Temp. Coefficient -30mV/°C
	Standby Use	No limit on initial charging current. Voltage 13.5V ~ 13.8V @ 25°C Temp. Coefficient -20mV/°C
	Capacity affected by Temperature	40°C 103% 25°C 100% 0°C 86%
<b>Design Floating Life at 20°C</b>	10 Years	

Self Discharge

Ultracell® UCG batteries may be stored for up to 9 months at 25°C and then a refresh charge is required. For higher temperatures the time intervals will be shorter.

Constant Current Discharge / Constant Power Discharge At 25°C (Amperes & Watts/Cell)

A = Amperes W = Watts

F.V/TIME	15 min	30 min	60 min	2 hours	3 hours	4 hours	5 hours	6 hours	8 hours	10 hours	20 hours
A \ W											
1.80V/cell	390	246	155	95.0	66.7	54.7	46.7	40.8	32.0	27.5	12.9
	4285	2755	1773	1101	784	643	552	482	380	328	25.6
1.75V/cell	412	255	160	97.5	68.8	56.4	48.1	42.1	33.0	27.7	13.0
	4524	2860	1829	1129	809	663	569	497	392	331	25.8
1.70V/cell	427	261	164	99.0	69.2	56.8	48.5	42.4	33.2	27.9	13.3
	4683	2931	1866	1146	814	668	573	501	395	333	26.3
1.65V/cell	443	270	168	99.9	69.7	57.2	48.8	42.7	33.5	27.9	13.4
	4863	3024	1915	1157	820	672	577	504	398	334	26.5
1.60V/cell	454	275	171	100	70.1	57.5	49.1	42.9	33.7	28.0	13.5
	4982	3086	1944	1164	825	676	580	507	400	334	26.7



**Discharge Characteristics**

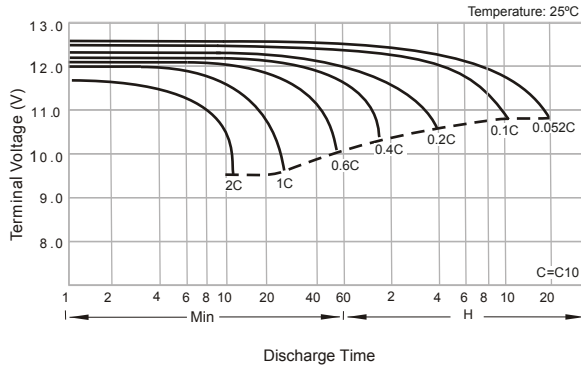

**Float Charging Characteristics**

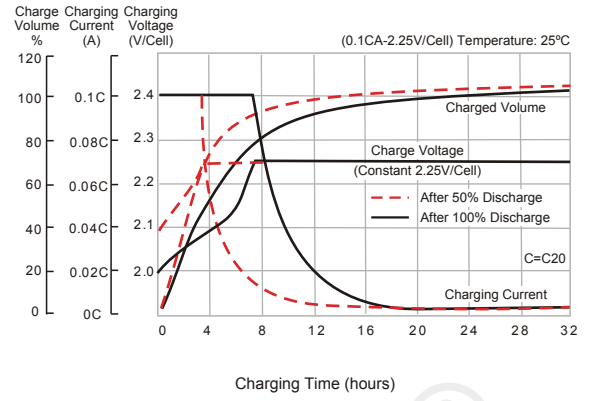

**Temperature Effects in Relation to Battery Capacity**

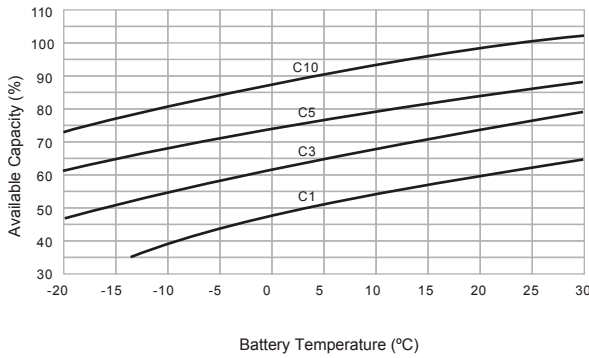

**Effect of Temperature on Long Term Float Life**

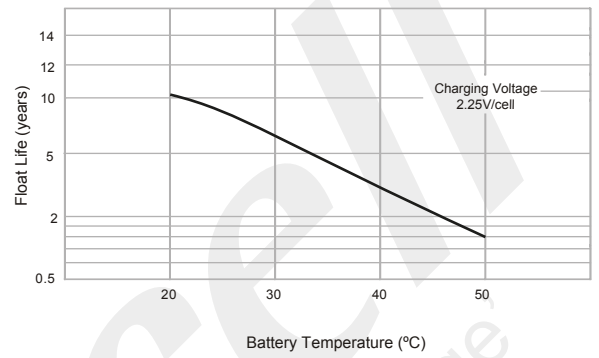

**Cycle Life in Relation to Depth of Discharge**

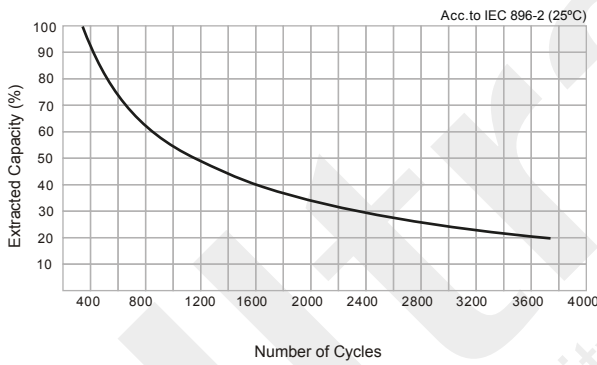

**General Relation of Capacity vs. Storage Time**

